



Parts for Trucks, Trailers & Buses

14

LIGHTING

*Proven, reliable and
always innovative.*

TRP offers reliable aftermarket products that are designed and tested to exceed customers' expectations regardless of the vehicle make, model or age.



**BULBS • INCANDESCENT LAMPS •
LED LAMPS • MOUNTING ACCESSORIES**



Tested. Reliable. Guaranteed.

Lighting

Choosing the right replacement part or service for your vehicle—whether you own one, or a fleet—is one of the most important decisions you can make for your business. And, with tested TRP® parts it’s an easy decision.

Regardless of the make you drive, TRP® quality replacement parts are engineered to fit your truck, trailer or bus. Choose the parts that give you the best value for your business. Check them out at an approved TRP® retailer near you.

The cross reference information in this catalog is based upon data provided by several industry sources and our partners. While every attempt is made to ensure the information presented is accurate, we bear no liability due to incorrect or incomplete information.

Product Availability

Due to export restrictions and market demands, not all products are always available in every location. Check for availability in your area with your local TRP® Distributor.

No part of this marketing material may be reproduced in any manner without written permission from TRP® North America.

TABLE OF CONTENTS

LIGHTING

INCANDESCENT LAMPS

- [Incandescent Directional Lamps](#) 14-5
- [Incandescent Marker Lamps](#) 14-5
- [Incandescent Marker Lamps - Double Bull’s Eye](#) 14-6
- [Incandescent Marker Lamps - Oblong](#) 14-6
- [Incandescent STT Marker Lamps - Oblong](#) 14-7
- [Incandescent Marker Lamps - X2A, X3A and X3AG2](#) 14-7
- [Incandescent Marker Lamps - Rectangle](#) 14-8
- [Incandescent Marker Lamps - Round](#) 14-9
- [Incandescent Stop, Tail & Turn Lamps - Round](#) 14-9

LED LIGHTING

- [LED Auxiliary Cargo & Work Lamp](#) 14-12
- [LED Auxiliary/ Fog Lamp](#) 14-12
- [LED Backup Lamps](#) 14-13
- [LED Courtesy Chrome Lamps](#) 14-13
- [LED - Driving Light with Housing](#) 14-14
- [LED Interior Lamps](#) 14-14

TRP® North America

750 Houser Way N.
Renton, WA 98057

www.trpparts.com

LED Interior Lamps - DNL T Housing	14-15	LED Turn Lamps - “Lollipop” (Double Sided)	14-31
LED Interior Lamps - Utility Lamp	14-15		
LED Marker Lamps - Beehive	14-16	BULBS	
LED Marker Lamps - Cab	14-16	Halogen Bulbs	14-32
LED Marker Lamps - Clearance, Oval	14-17	Miniature Incandescent Bulbs	14-38
LED Marker Lamps - Clearance, Small Round	14-17	MOUNTING ACCESSORIES	
LED Marker Lamps - Double Bull’s Eye	14-18	Bases	14-57
LED Marker Lamps - Oval	14-19	Bezels - Chrome	14-57
LED Marker Lamps - P168	14-19	Bezels - Chrome Plated	14-58
LED Marker Lamps - Peterbilt Style	14-20	Grommets	14-59
LED Marker Lamps - Rectangle	14-21	Lighting Harnesses - Continuous	14-59
LED Side Marker Lamps with Diamond Base - Rectangle	14-22	Lighting Pigtails	14-60
LED Marker Lamps - Super 21	14-24		
LED Marker Lamps - Thin Line	14-25		
LED Marker Lamps - Tunnel Light	14-25		
LED Park, Tail & Turn Marker Lamps	14-26		
LED Side Marker Lamps - Round	14-27		
LED Side Marker Lamp - Rectangle	14-28		
LED Side Marker Lamps - Triangle	14-28		
LED Stop, Tail & Turn Marker Lamps - Round	14-29		
LED Stop, Tail & Turn Marker Lamps - Oval	14-30		
LED Stop, Tail & Turn Marker Lamps - Rectangle	14-30		
LED Turn Lamp - Single Sided	14-31		
LED Turn Lamps - Double Sided	14-31		



INCANDESCENT LIGHTS

FEATURES & BENEFITS

- » Long Life bulbs which Reduces Maintenance
- » Meets DOT regulations to conforms to Federal Transportation requirements

RELATED PARTS

- » Dielectric Grease:
Part Number:
97943, 01991702GR0,
99170-1GR0



LB010402



LB011901



LB046701



LB046402

INCANDESCENT LAMPS

TRP® provides premium lamps that have a proven reputation for high quality service with exceptional durability. TRP® Incandescent lamps provide excellent durability as a result of the manufacturing process which provides long life bulbs and meets/exceeds industry standards.

CROSS REFERENCE

TRP®	Truck LitePart	Grote	Bulb #	Min Life	Lens Mat.	Description
LB046402	19200R	46742	193E	2000	PC	Lamp - Marker, Rect 4 inch red
LB046301	19200Y	46743	193E	2000	PC	Lamp - Marker, Rect 4 inch amber
LB046702	21002R	46082GR0	193E	2000	AC	Lamp - Marker, Rect 6 inch Red
LB046701	21002Y	46083GR0	193E	2000	AC	Lamp - Marker, Rect 6 inch Amber
LB045302	30200R	45822	193E	2000	PC	Lamp - Marker 2 inch round red
LB045201	30200Y	45823	193E	2000	PC	Lamp - Marker 2 inch round amber
LB045902	10202R	45812	193E	2000	PC	Lamp - Marker 2.5 inch round red
LB045801	10202Y	45813	193E	2000	PC	Lamp - Marker 2.5 inch round amber
LB012202	60202R	52892-5GR0	2057E	1200/5000	PC	Lamp - STT Oblong 6 inch Red
LB012001	60202Y	52893-5GR0	2057E	1200/5000	PC	Lamp - STT Oblong 6 inch amber
LB011901	60215Y	52193	2057E	1200/5000	PC	Turn/Marker - Mid Side - 6 inch Oblong, Amber
LB010402	40242R/40282R	52952GR0/52922	2057E	1200/5000	PC	Lamp - STT Round, Red Grommet
LB040113	15200C	60271	193E	2000	PC	Lamp - Marker, Rect 2.5 inch, Clear
LB042502	15200R	46412	193E	2000	PC	Lamp - Marker, Rect 2.5 inch, Red
LB046201	15200Y	46413	193E	2000	PC	Lamp - Marker, Rect 2.5 inch, Amber
LB047101	45663		193E	2000	PC	Lamp - Marker, 4 inch oblong w/bezel
LB046501	1211AS1G	46793	194	2500	PC	Lamp - Marker, Bulls Eye Amber
LB046502	1211S1G	46792	194	2500	PC	Lamp - Marker, Bulls Eye Red



Scan the code for more information.
Get the free mobile app at <http://gettag.mobi>

INCANDESCENT LAMPS



Bulbs

See Page 14-34

INCANDESCENT DIRECTIONAL LAMPS



LB010102

Table 14-1: Incandescent Directional Stop, Tail & Turn Lamps

Part No.	Lens Color	Side	Size	Bulb	Notes
LB010102	Red	Right Hand	6" x 7"	LB1157	3-post
LB010202	Red	Left Hand	6" x 7"	LB1157	3-post

INCANDESCENT MARKER LAMPS

Table 14-2: Incandescent Marker Lamps

Part No.	Description
MD0680	Marker Lamp, Incandescent - Amber Lens

INCANDESCENT MARKER LAMPS - DOUBLE BULL'S EYE

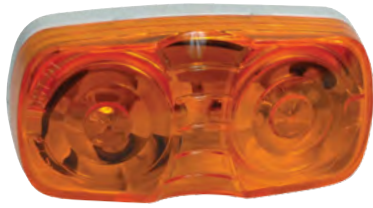

LB046501



LB046502

Table 14-3: Incandescent Double Bull's Eye Marker Lamps

Part No.	Lens Color	Size	Qty	Bulb
LB046501	Amber	2" x 3 - 7/8"	1	LB194
LB046502	Red	2" x 3 - 7/8"	1	LB194

INCANDESCENT MARKER LAMPS - OBLONG



LB011901



LB047101

Table 14-4: Oblong Incandescent Marker Lamps

Part No.	Lens Color	Size	Qty	Bulb	Notes
LB047101	Amber	4"	1	LB193	
LB011901	Amber	6"	1	LB2057	Side Turn Lamp

INCANDESCENT STT MARKER LAMPS - OBLONG



LB012001



LB012202

Table 14-5: Oblong Incandescent STT Marker Lamps

Part No.	Lens Color	Size	Qty	Bulb
LB012001	Amber	6"	1	LB2057
LB012202	Red	6"	1	LB2057

INCANDESCENT MARKER LAMPS - X2A, X3A AND X3AG2



MD4305



MD4306

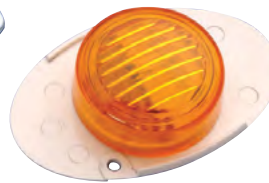

MD0254



MD0256

Table 14-6: Incandescent X2A & X3A Marker Lights

Part No.	Description
X2A LIGHTS	
MD4305	Marker Lamp - X2A Lights, Red Lens, Bulb, Chrome Bezel
MD4306	Marker Lamp - X2A Lights, Amber Lens, Bulb, Chrome Bezel
X3A LIGHTS	
MD0254	Marker Lamp - X3A Lights, Amber Lens, No Bezel
MD0256	Marker Lamp - X3A Lights, Red Lens, No Bezel
MD4302	Marker Lamp - X3A Lights, Red Lens, Bulb, Chrome Bezel
MD4303	Marker Lamp - X3A Lights, Amber Lens, Bulb, Chrome Bezel
X3AG2 LIGHTS	
MD0669	Marker Lamp - X3AG2 Lights, Amber Lens

Lamps use pigtail LL091710

INCANDESCENT MARKER LAMPS - RECTANGLE



LB046701



LB046702



LB040113



LB042502



LB046201



LB046301



LB046402

Table 14-7: Rectangle Incandescent Marker Lamps

Part No.	Lens Color	Size	Qty	Bulb
LB040113	Clear	2-1/2"	1	LB193
LB042502	Red	2-1/2"	1	LB193
LB046201	Amber	2-1/2"	1	LB193
LB046301	Amber	4"	1	LB193
LB046402	Red	4"	1	LB193
LB046701	Amber	6"	1	LB193
LB046702	Red	6"	1	LB193

INCANDESCENT MARKER LAMPS - ROUND



LB045201



LB045302



LB045801



LB045902

Table 14-8: Round Incandescent Marker Lamps

Part No.	Lens Color	Size	Qty	Bulb
LB045201	Amber	2"	1	LB193
LB045302	Red	2"	1	LB193
LB045801	Amber	2-1/2"	1	LB193
LB045902	Red	2-1/2"	1	LB193

INCANDESCENT STOP, TAIL & TURN LAMPS - ROUND



LB010402

Table 14-9: Incandescent Stop, Tail & Turn Lamps

Part No.	Lens Color	Size	Qty	Bulb
LB010402	Red	4"	1	LB2057



LED LIGHTS

FEATURES & BENEFITS

- » 100,000-hour life reduces maintenance costs
- » High diode count increases vehicle conspicuity
- » Complete sealing of electronics in epoxy prevents corrosion and moisture
- » Meets DOT FMVS108/CMVSS108 regulations
- » 10 Year Limited Warranty

RELATED PARTS

- » Dielectric Grease:

Part Number:

97943

01991702GR0

99170-1GR0

LED LIGHTS

The TRP® lighting program offers a wide selection of energy efficient and durable LED lights. TRP® LED Lights do not contain filament and have a high impact polycarbonate lens, providing improved visibility at night.



LL046602



LL046102



LL045201



LL060202



LL011402



LL060109



LL044412

CROSS REFERENCE

TRP®	Maxxima	Grote	Truck Lite	Description
LL010402		G4002GR0	4050	Stop, Turn, Tail (4") 44 LED, Red, Grommet Mount
LL045201	M09100Y	G3003	3050A	Clearance/Marker (2"), 9 LED, Amber



Scan the code for more information.
Get the free mobile app at <http://gettag.mobi>

CROSS REFERENCE CONTINUED

TRP®	Maxxima	Grote	Description
LL045801	PL7100A	M11300Y	Clearance/Marker (2-1/2"), 13 LED, Amber
LL045902	PL7100R	M16280R	Clearance/Marker (2-1/2"), 13 LED, Red
LL046501	PL7120A		Clearance/Marker (3-7/8" x 2"), 16 LED, Double Bull's-Eye, Amber
LL046602	PL7120R		Clearance/Marker (3-7/8" x 2"), 16 LED, Double Bull's-Eye, Red
LL047101	PL7131A	M20332Y	Clearance/Marker (6-1/4" x 1-7/8"), 2 LED, Amber
LL011901	PL7170A	M63120Y	Side Turn Signal/Marker (6-1.2" x 2-1/4"), 10 LED, Amber
LL046301	PL7190A	M20350Y	Clearance/Marker (1-1/4" x 4"), 12 LED, Amber
LL046402	PL7190R	M20350R	Clearance/Marker (1-1/4" x 4"), 12 LED, Red
LL045201	PL7300A	M09100Y	Clearance/Marker (2"), 9 LED, Amber
LL045302	PL7300R	M09100R	Clearance/Marker (2"), 9 LED, Red
LL045501	PL7302A	M09105Y	Clearance/Marker (2"), Beehive, 9 LED, Amber
LL010402	PL7400R	M42100R	Stop, Turn, Tail (4") 44 LED, Red, Grommet Mount
LL012001	PL7600A	M63100Y	Stop, Turn, Tail (6"), 52 LED, Amber, Grommet Mount
LL012202	PL7600R	M63100R	Stop, Turn, Tail (6"), 52 LED, Red, Grommet Mount
LL046701	PL721A	M20390Y	Clearance/Marker (2" x 5-7/8"), 10 LED, Super 21, Amber
LL047301	PL7150A	M20320Y	Clearance/Marker (1-1/2" x 2-1/2") 3 LED, Amber
LL047302	PL7150R	M20320R	Clearance/Marker (1-1/2" x 2-1/2") 3 LED, Red

LED LIGHTING



Bezels
See Page 12-58

LED AUXILIARY CARGO & WORK LAMP



Table 14-10: LED Auxiliary Cargo & Work Lamp

Part No.	Diode Color	Lens Color	Size	Qty	Notes
20 DIODES					
LL050105	White	Clear	1 - 1/2" x 18"	1	Surface Screw-mount, 2 Wires

LED AUXILIARY/ FOG LAMP



Table 14-11: LED Auxiliary/Fog Lamps

Part No.	Diode Color	Lens Color	Size	Qty
9 DIODES				
LL090810	Clear	Purple	2" x 1-3/4"	1

LED BACKUP LAMPS



LL047805



LL044412



LL080305

Table 14-12: LED Backup Lamps

Part No.	Diode Color	Lens Color	Size	Base/Bezel	Qty
20 DIODES ROUND					
LL047805	White	Clear	7"		1
45 DIODES ROUND					
LL044412	White	Clear	4"	MC0102 or MC0106	1
45 DIODES OVAL - GROMMET MOUNT, HARD WIRED					
LL080305	White	Clear	6"		1

LED COURTESY CHROME LAMPS



Table 14-13: LED Courtesy Chrome Lamps

Part No.	Diode Color	Lens Color	Size	Qty
3 DIODES				
LL070601	Amber	Clear	1" x 1"	1
LL070707	Blue	Clear	1" x 1"	1
LL071002	Red	Clear	1" x 1"	1
LL070805	White	Clear	1" x 1"	1

LED - DRIVING LIGHT WITH HOUSING

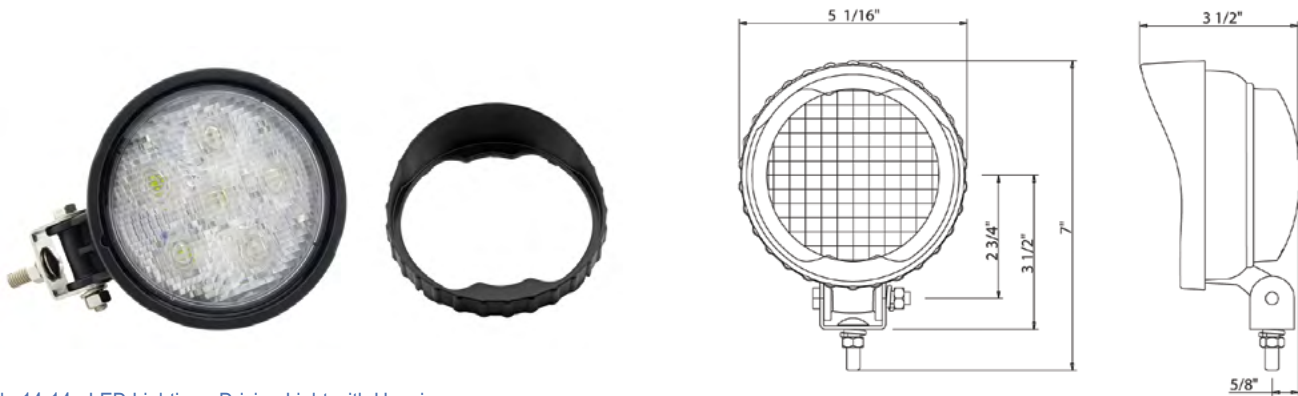

Table 14-14: LED Lighting - Driving Light with Housing

Part No.	Material	Diodes	Lumens	Amps	Light Shape	Notes
LL091605	Driving Light with Black Aluminum Housing, Poly Lens	6	420	1.26	Oval	Two 11" Leads, w/ Mtg. Bolt

LED INTERIOR LAMPS

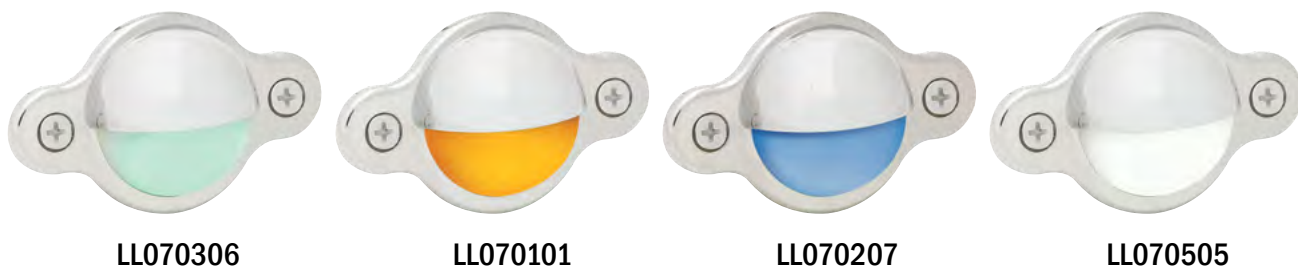
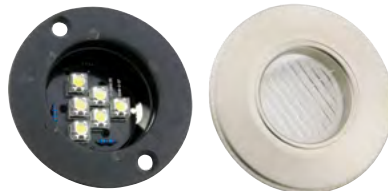

Table 14-15: LED Interior Lamps

Part No.	Diode Color	Lens Color	Size	Qty
1 DIODE				
LL070101	Amber	Clear	1-5/8" x 2-3/4"	1
LL070207	Blue	Clear	1-5/8" x 2-3/4"	1
LL070306	Green	Clear	1-5/8" x 2-3/4"	1
LL070402	Red	Clear	1-5/8" x 2-3/4"	1
LL070505	White	Clear	1-5/8" x 2-3/4"	1

LED INTERIOR LAMPS - DNLT HOUSING



LL090310

Table 14-16: DNLT Housing For Interior Lamps

Part No.	Diode Color	Lens Color	Size	Qty	Notes
6 DIODES					
LL090310	Clear	Clear	1.5"	1	Plastic Housing, Flange Mount, Pearl Nickel Finish, Asymmetric Lens

LED INTERIOR LAMPS - UTILITY LAMP



Table 14-17: LED Utility Lamp

Part No.	Diode Color	Lens Color	Size	Qty	Notes
50 DIODES					
LL073105	White	Clear	14" x 3-5/8"	1	Utility Lamp, Clear, ABS Housing, 3-way Switch

LED MARKER LAMPS - BEEHIVE



LL043503



LL046001



LL046102



LL045501

Table 14-18: Beehive LED Marker Lamps

Part No.	Diode Color	Lens Color	Size	Base/Bezel	Qty
9 DIODES					
LL043503	Red	Red	2"	MC1615 or MC1616	1
LL045501	Amber	Amber	2"	MC1615 or MC1616	1
LL045603	Amber	Clear	2"	MC1615 or MC1616	1
LL045702	Red	Red	2"	MC1615 or MC1616	1
13 DIODES					
LL040803	Amber	Clear	2 - 1/2"	MC0101 or MC0105	1
LL040904	Red	Clear	2 - 1/2"	MC0101 or MC0105	1
LL046001	Amber	Amber	2 - 1/2"		1
LL046102	Red	Red	2 - 1/2"		1

LED MARKER LAMPS - CAB



LL043001



LL043102

Table 14-19: Cab LED Marker Lamps

Part No.	Diode Color	Lens Color	Size	Qty	Notes
12 DIODES					
LL043001	Amber	Amber	2 - 1/4" x 4 - 1/2"	1	2 Bare Wires
LL043102	Red	Red	2 - 1/4" x 4 - 1/2"	1	2 Bare Wires

LED MARKER LAMPS - CLEARANCE, OVAL



Table 14-20: Oval Clearance LED Marker Lamps

Part No.	Diode Color	Lens Color	Size	Base/Bezel	Qty
2 DIODES					
LL044701	Amber	Amber	2" x 3"	MD4304	1
LL044803	Amber	Clear	2" x 3"	MD4304	1
LL045004	Red	Clear	2" x 3"	MD4304	1
LL044902	Red	Red	2" x 3"	MD4304	1
4 DIODES					
LL047303	Amber	Clear	2-1/4" x 6-1/2"	MD4307	1
LL047503	Amber	Clear/ Reflective	2-1/4" x 6-1/2"	MD4307	1
LL042204	Red	Clear	2-1/4" x 6-1/2"	MD4307	1
LL042304	Red	Clear/ Reflective	2-1/4" x 6-1/2"	MD4307	1
LL042102	Red	Red	2-1/4" x 6-1/2"	MD4307	1
LL047602	Red	Reflective	2-1/4" x 6-1/2"	MD4307	1

LED MARKER LAMPS - CLEARANCE, SMALL ROUND



Table 14-21: LED Marker Lamps

Part No.	Lens Color	Size	Qty	Note
1 DIODE				
LL047901	Amber	3/4"	1	w/ Bare Wires & Grommet
LL048002	Red	3/4"	1	w/ Bare Wires & Grommet

LED MARKER LAMPS - CLEARANCE, OBLONG



LL044103



LL044001



LL044302

Table 14-22: Oblong LED Clearance Marker Lamps

Part No.	Diode Color	Lens Color	Size	Qty	Notes
12 DIODES					
LL044001	Amber	Amber	2" x 5-3/4"	1	with Bezel
LL044103	Amber	Amber	2" x 5-3/4"	1	with Bezel
LL044204	Red	Red	2" x 5-3/4"	1	with Bezel
LL044302	Red	Red	2" x 5-3/4"	1	with Bezel

LED MARKER LAMPS - DOUBLE BULL'S EYE

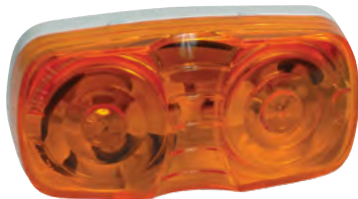

LL046501



LL046602



LL041403

Table 14-23: Double Bull's Eye LED Marker Lamps

Part No.	Diode Color	Lens Color	Size	Base/Bezel	Qty
13 DIODES					
LL041403	Amber	Clear	2" x 3 - 7/8"	MC8973	1
LL041504	Red	Clear	2" x 3 - 7/8"	MC8973	1
LL046501	Amber	Amber	2" x 3 - 7/8"	MC8973	1
LL046602	Red	Red	2" x 3 - 7/8"	MC8973	1

LED MARKER LAMPS - OVAL



LL047201



LL047401

Table 14-24: Oval LED Marker Lamps

Part No.	Diode Color	Lens Color	Size	Base/Bezel	Qty
4 DIODES					
LL047201	Amber	Amber	2 - 1/4" x 6 - 1/2"	MD4307	1
LL047401	Amber	Reflective	2 - 1/4" x 6 - 1/2"	MD4307	1

LED MARKER LAMPS - P168



MD4701A



MD4701AC

Table 14-25: LED Marker Lamps - P168

Part No.	Description
MD4701A	Marker Light - P168 - Amber Light with Amber Lens
MD4701AC	Marker Light - P168 - Amber Light with Clear Lens

LED MARKER LAMPS - PETERBILT STYLE



LL042002



LL047101



LL041904



LL041904



LL047003

Table 14-26: Rectangle LED Marker Lamps - Peterbilt Style

Part No.	Diode Color	Lens Color	Size	Qty	Notes
2 DIODES					
LL042002	Red	Red	1 - 7/8" x 6 - 1/4"	1	Peterbilt Style
LL047101	Amber	Amber	1 - 7/8" x 6 - 1/4"	1	Peterbilt Style
12 DIODES					
LL047003	Amber	Clear	1 - 7/8" x 6 - 1/4"	1	Peterbilt Style
LL041904	Red	Clear	1 - 7/8" x 6 - 1/4"	1	Peterbilt Style
LL041802	Red	Red	1 - 7/8" x 6 - 1/4"	1	Peterbilt Style
LL046901	Amber	Amber	1 - 7/8" x 6 - 1/4"	1	Peterbilt Style

LED MARKER LAMPS - RECTANGLE



LL042403



LL046301



LL047302



LL046402

Table 14-27: Rectangle LED Marker Lamps

Part No.	Diode Color	Lens Color	Size	Base/Bezel	Qty
3 DIODES					
LL047302	Clear	Red	1.2" x 2.6"	LL091110	1
LL047301	Amber	Amber	1.2" x 2.6"	LL091110	1
8 DIODES					
LL042403	Amber	Clear	2 - 5/8" x 1 - 1/4"	LL091110	1
LL042604	Red	Clear	2 - 5/8" x 1 - 1/4"	LL091110	1
12 DIODES					
LL046301	Amber	Amber	1 - 1/4" x 4"	LL091010	1
LL042703	Amber	Clear	1 - 1/4" x 4"	LL091010	1
LL042804	Red	Clear	1 - 1/4" x 4"	LL091010	1
LL046402	Red	Red	1 - 1/4" x 4"	LL091010	1

LED SIDE MARKER LAMPS WITH DIAMOND BASE - RECTANGLE



LL072001



LL073004



LL072401



LL072611



LL072103



LL072304



LL072202

Table 14-28: Rectangle LED Marker Lamps with Diamond Base

Part No.	Diode Color	Lens Color	Size	Qty	Notes
2 DIODES					
LL072001	Amber	Amber	3/4" x 3 - 3/8"	1	2 Wires
LL073004	Red	Clear	3/4" x 3 - 3/8"	1	2 Wires
LL072103	Amber	Clear	2 - 1/4" x 6 - 1/2"	1	2 Wires
LL072304	Red	Clear	2 - 1/4" x 6 - 1/2"	1	2 Wires
LL072202	Red	Clear	2 - 1/4" x 6 - 1/2"	1	2 Wires
LL072401	Amber	Amber	3 - 1/4" x 1 - 3/16"	1	2 Wires
LL072611	Blue	Clear	3 - 1/4" x 1 - 3/16"	1	2 Wires
LL072503	Clear	Clear	3 - 1/4" x 1 - 3/16"	1	2 Wires
LL072812	Green	Clear	3 - 1/4" x 1 - 3/16"	1	2 Wires
LL072902	Red	Red	3 - 1/4" x 1 - 3/16"	1	2 Wires
LL072705	White	Clear	3 - 1/4" x 1 - 3/16"	1	2 Wires

LED MARKER LAMPS - ROUND

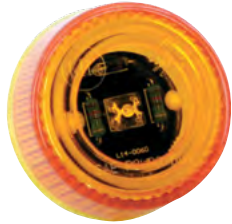

LL041201



LL041302



LL045201



LL045103

Table 14-29: Round LED Marker Lamps

Part No.	Diode Color	Lens Color	Size	Base/Bezel	Qty	Notes
1 DIODE						
LL041201	Amber	Amber	2"		1	
LL041302	Red	Red	2 - 1/2"		1	
9 DIODES						
LL045103	Amber	Clear	2"	MC1615 or MC1616	1	
LL045201	Amber	Amber	2"	MC1615 or MC1616	1	
LL045302	Red	Red	2"	MC1615 or MC1616	1	
LL045404	Red	Clear	2"	MC1615 or MC1616	1	

LED MARKER LAMPS - SCHOOL BUS



PL7122A



LL041601



LL041702



LL060109



LL060202

Table 14-30: LED School Bus Marker Lamps

Part No.	Diode Color	Lens Color	Size	Qty	Notes
10 DIODES SQUARE					
PL7122A	White	Amber	4"	1	with Chrome Brush Guard
15 DIODES TRIANGLE					
LL041601	Amber	Amber	2 - 3/4" x 3 - 1/2"	1	
LL041702	Red	Red	2 - 3/4" x 3 - 1/2"	1	
31 DIODES ROUND					
LL060109	Amber	Reflective	7"	1	
LL060202	Red	Reflective	7"	1	

LED MARKER LAMPS - SUPER 21



LL046701



LL046701

Table 14-31: Super 21 LED Marker Lamps

Part No.	Diode Color	Lens Color	Size	Qty
10 DIODES				
LL046701	Amber	Amber	2" x 5 - 7/8"	1
LL046802	Red	Red	2" x 5 - 7/8"	1

LED MARKER LAMPS - THIN LINE



LL044601



LL043802

Table 14-32: Thin Line LED Marker Lamps

Part No.	Diode Color	Lens Color	Size	Qty	Notes
7 DIODES					
LL044601	Amber	Amber	3/4" x 4"	1	Thin Line Profile
LL043802	Red	Red	3/4" x 4"	1	Thin Line Profile

LED MARKER LAMPS - TUNNEL LIGHT



Table 14-33: LED Marker Lamps - Tunnel Light

Part No.	Description
MD5501	Marker Tunnel Light - PB - M179 Amber Light

LED MARKER LAMPS - X2AG2

Table 14-34: LED Marker Lamps - X2AG2

Part No.	Description
MD5584	Marker Lamp - X2AG2 LED Lights, Amber Lens - with 180 Bullet Plugs - Replacement, Bezel sold separately, Lamp uses pigtail LL091710.

LED PARK, TAIL & TURN MARKER LAMPS



LL010601



LL010301



LL011801



LL012401

Table 14-35: LED Park, Turn & Tail Marker Lamps

Part No.	Diode Color	Lens Color	Base/Bezel	Mounting Style
44 DIODES 4" ROUND				
LL010601	Amber	Amber	MC0102 or MC0106	Flange
LL011003	Amber	Clear	MC0102 or MC0106	Grommet
LL011103	Amber	Clear	MC0102 or MC0106	Flange
LL010301	Amber	Amber	MC0102 or MC0106	Grommet
52 DIODES 3" X 5" RECTANGLE				
LL011801	Amber	Amber		Grommet
52 DIODES 6" OVAL				
LL012103	Amber	Clear	MC0104 or MC0107	Grommet
LL012401	Amber	Amber	MC0104 or MC0107	Flange
LL012704	Red	Clear	MC0104 or MC0107	Flange
60 DIODES 6" OVAL				
LL012603	Amber	Clear	MC0104 or MC0107	Flange

LED SIDE MARKER LAMPS - ROUND

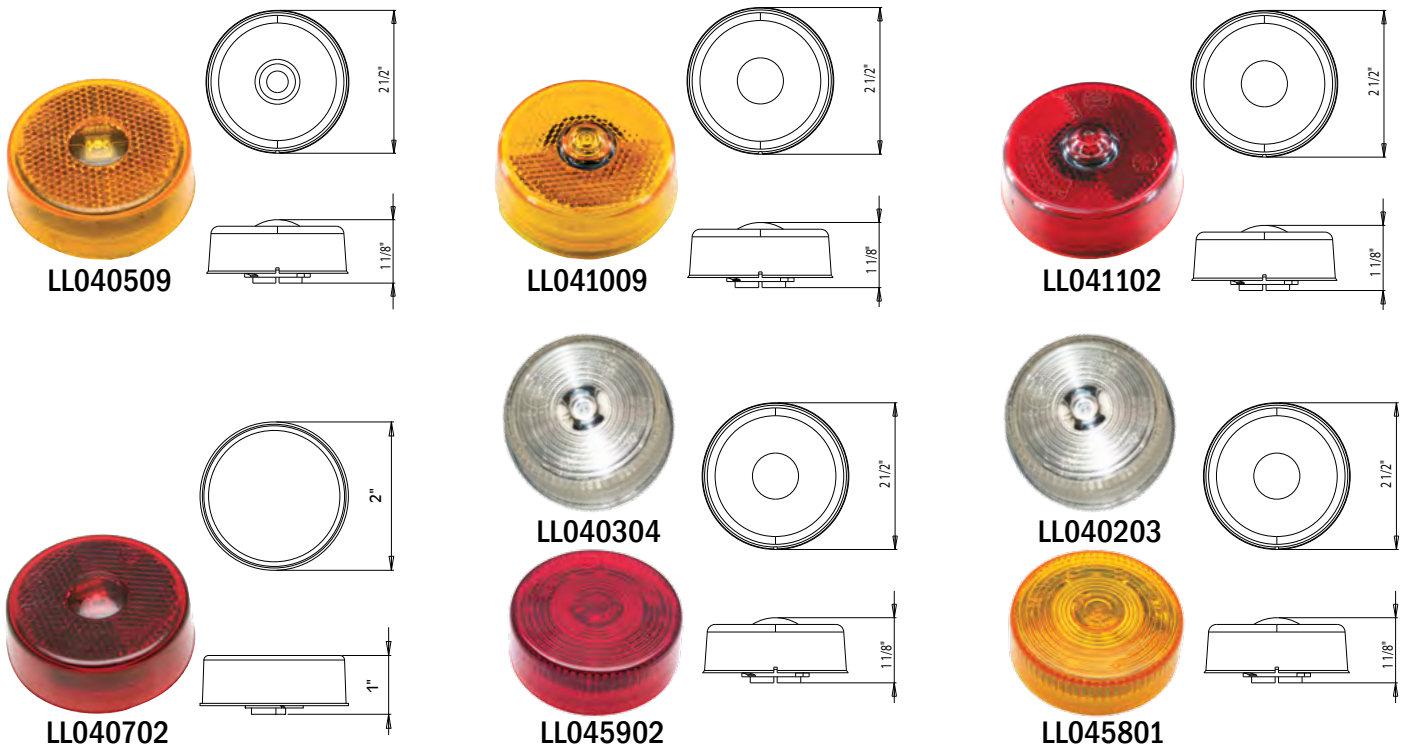

Table 14-36: Round LED Side Marker Lamps

Part No.	Diode Color	Lens Color	Size	Base/Bezel	Qty	Notes
1 DIODE						
LL041102	Red	Reflective	2 - 1/2"		1	Grommet Mount, 2-Pole Plug, PC Lens, ABS Housing, Light Source: 1 Diode - 14V, .048 amp
LL041009	Amber	Reflective	2 - 1/2"		1	Grommet Mount, 2-Pole Plug, PC Lens, ABS Housing, Light Source: 1 Diode - 14V, .036 amp
5 DIODES						
LL040509	Amber	Reflective	2 - 1/2"	MC0101 or MC0105	1	Grommet Mount, 2-Pole Plug, PC Lens, ABS Housing, Light Source: 5 Diodes - 14V, .073 amp
LL040702	Red	Reflective	2 - 1/2"	MC0101 or MC0105	1	Grommet Mount, 2-Pole Plug, PC Lens, ABS Housing, Light Source: 5 Diodes - 14V, .071 amp
13 DIODES						
LL040203	Amber	Clear	2 - 1/2"		1	Grommet Mount, 2-Pole Plug, PC Lens, ABS Housing, Light Source: 13 Diodes - 14V, .129 amp
LL040304	Red	Clear	2 - 1/2"		1	Grommet Mount, 2-Pole Plug, PC Lens, ABS Housing, Light Source: 13 Diodes - 14V, .091 amp
LL045801	Amber		2 - 1/2"		1	Grommet Mount, 2-Pole Plug, PC Lens, ABS Housing, Light Source: 13 Diodes - 14V, .129 amp
LL045902	Red	Red	2 - 1/2"		1	Grommet Mount, 2-Pole Plug, PC Lens, ABS Housing, Light Source: 13 Diodes - 14V, .091 amp

LIGHTING

LED SIDE MARKER LAMP - RECTANGLE



Table 14-37: Rectangle LED Side Marker Lamps

Part No.	Diode Color	Lens Color	Size	Qty
10 DIODES				
LL011901	Amber	Amber	2 - 1/4" x 6 - 1/2"	1

LED SIDE MARKER LAMPS - COMB, RECTANGLE



LL043201



LL043302

Table 14-38: Rectangle Comb LED Side Marker Lamps

Part No.	Diode Color	Lens Color	Qty	Notes
14 DIODES				
LL043201	Amber	Amber	2"x4"	P2
LL043302	Red	Red	2"x4"	P2

LED SIDE MARKER LAMPS - TRIANGLE



LL021303



LL021201

Table 14-39: Triangle LED Side Marker Lamps

Part No.	Diode Color	Lens Color	Qty
37 DIODES			
LL021201	Amber	Amber	1
LL021303	Clear	Amber	1

LED STOP, TAIL & TURN MARKER LAMPS - ROUND



LL011202



LL011402



LL010402



LL010504



LL010902



LL010804

Table 14-40: LED Stop, Turn & Tail Marker Lamps

Part No.	Diode Color	Lens Color	Base/Bezel	Mounting Style	Notes
10 DIODES 4" ROUND					
LL011202	Red	Red		Grommet	with Standard Plug
LL011402	Red	Red		Surface	
12 DIODES 4" ROUND					
LL010902	Red	Red		Grommet	
44 DIODES 4" ROUND					
LL010804	Red	Clear	MC0102 or MC0106	Flange	
LL010504	Red	Clear	MC0102 or MC0106	Grommet	
LL010402	Red	Red	MC0102 or MC0106	Grommet	

LED STOP, TAIL & TURN MARKER LAMPS - OVAL



LL012502



LL012304



LL012202



LL043902



LL012802

Table 14-41: LED Stop, Turn & Tail Marker Lamps - Oval

Part No.	Diode Color	Lens Color	Size	Base/Bezel	Mtg Style	Notes
10 DIODES						
LL012802	Red	Red	6"		Grommet	Standard Plug
LL043902	Red	Red	6"		Surface	Bare Wire
52 DIODES						
LL012502	Red	Red	6"	MC0104 or MC0107	Flange	
60 DIODES						
LL012304	Red	Clear	6"	MC0104 or MC0107	Grommet	
LL012202	Red	Red	6"	MC0104 or MC0107	Grommet	

LED STOP, TAIL & TURN MARKER LAMPS - RECTANGLE



Table 14-42: LED Stop, Turn & Tail Marker Lamps - Rectangle

Part No.	Diode Color	Lens Color	Size	Mounting Style
52 DIODES				
LL047702	Red	Red	3" x 5"	Grommet

LED TURN LAMP - SINGLE SIDED

Table 14-43: LED Single Sided Turn Lamp

Part No.	Diode Color	Lens Color	Size	Mtg Style
45 DIODES				
LL021101	Red	Red	4"	Surface



LED TURN LAMPS - DOUBLE SIDED

Table 14-44: LED Double Sided Turn Lamp

Part No.	Diode Color	Lens Color	Size
45 DIODES ROUND			
LL021009	Clear	Amber/ Red	4"
45 DIODES SQUARE			
LL021401	Clear	Amber/ Amber	4"
LL021509	Clear	Amber/ Red	4"
LL021609	Clear	Amber/ Red	4"



LL021609

LED TURN LAMPS - "LOLLIPOP" (DOUBLE SIDED)



LL020601



LL020714



LL020809

Table 14-45: LED Double Sided Turn Lamp - Lollipop

Part No.	Diode Color	Lens Color	Size	Mounting Style
32 DIODE ROUND				
LL020601	Amber/ Amber	Amber	4 - 7/8" x 7"	Surface
LL020714	Red/ Amber	Clear	4 - 7/8" x 7"	Surface
LL020809	Red/ Amber	Red	4 - 7/8" x 7"	Surface

BULBS

HALOGEN BULBS



LBH164150

LBH164152

T2-1/2 P14.5S BASE

Table 14-46: T2-1/2 P14.5S Base

Part No.	Maximum Bulb Dia.	Volts	Amp	Qty
55 WATTS				
LBH164150	5/16" (7.9mm)	12	4.58	1
100 WATTS				
LBH164152	5/16" (7.9mm)	12	8.33	10

T3 - 1/4 PK22S BASE



Table 14-47: T3 - 1/4 PK22S Base

Part No.	Maximum Bulb Dia.	Volts	Amp	Qty
55 WATTS T3 - 1/4				
LBH364151	13/32" (10mm)	12	4.58	1



LIGHTING



Part# LB1157
Bulb, S8, 12.8/14v,
Bayonet Base, Clear



Part# LB194
Bulb, T3-1/4, 14v,
Wedge Base, Clear

FEATURES & BENEFITS

- » The long life bulbs reduce maintenance
- » Meets DOT regulations and Federal Transportation guidelines

RELATED PARTS

- » Dielectric grease

Part Number:
97943, 01991702GR0,
99170-1GR0

Used to provide a nonconductive lubricant and sealer for the connector

TRP® MINI BULBS

TRP® offers mini light bulbs that are OEM approved. These mini bulbs lead the industry by offering our customers high quality products at competitive pricing, service, and exceptional durability. Each high quality bulb meets and exceeds industry standards.

TRP® brand mini bulbs will outperform the competition. Our attention to high quality and efficient bulbs will provide for long-lasting reliability.

Scan the code for more information.

Get the free mobile app at <http://gettag.mobi>



T3 - 1/4 PX29T AXIAL PREFOCUS BASE

LB880



LB893

Table 14-48: T3 - 1/4 PX29T Axial Prefocus Base

Part No.	Maximum Bulb Dia.	Volts	Amp	Qty
27 WATTS				
LB880	13/32" (10mm)	12.8	2.10	1
37.5 WATTS				
LB893	13/32" (10mm)	12.8	2.93	1

T3 - 1/4 RIGHT ANGLE PREFOCUS BASE

Table 14-49: T3 - 1/4 Right Angle Prefocus Base

Part No.	Maximum Bulb Dia.	Volts	Amp	Qty
37.5 WATTS				
LB896	13/32" (10mm)	12.8	2.93	1

T4 P20D SPECIAL BASE

Table 14-50: T4 P20D Special Base

Part No.	Bulb Type	Maximum Bulb Dia.	Volts	Amp	Qty
65 WATTS					
LB9005XS	HB3A	1/2" (13mm)	12.8	5.08	1

T4 P22D RIGHT ANGLE PREFOCUS BASE



Table 14-51: T4 - 5/8 P22D Right Angle Prefocus Base

Part No.	Bulb Type	Maximum Bulb Dia.	Volts	Amp	Qty
55 WATTS					
LB9006	HB4	1/2" (13mm)	12.8	4.30	1
65 WATTS					
LB9005	HB3A	1/2" (13mm)	12.8	5.08	1

T4 PGJ19-2 BASE



Table 14-52: T4 PGJ19-2

Part No.	Bulb Type	Maximum Bulb Dia.	Volts	Amp	Qty	Notes
55 WATTS						
LBH1155LL	H11	1/2" (13mm)	12	4.58	1	Long-Life

T4 SC BAYONET BASE

Table 14-53: T4 SC Bayonet

Part No.	Maximum Bulb Dia.	Volts	Amp	Qty	Notes
50 WATTS					
LB795X	1/2" (13mm)	12.8	3.9	1	Single Contact

T4-5/8 P43T BASE

Table 14-54: T4-5/8 P43T Base

Part No.	Maximum Bulb Dia.	Volts	Amp	Qty
80/100 WATTS				
LBH4100/80W	5/8" (17mm)	12	8.33/6.66	1

T4-5/8 PX26D BASE



Table 14-55: T4-5/8 PX26D

Part No.	Maximum Bulb Dia.	Volts	Amp	Qty	Notes
55 WATTS					
LBH755WLL	5/8" (17mm)	12	4.58	1	Long-Life

T4 - 5/8 PX29T AXIAL PREFOCUS BASE



Table 14-56: T4 - 5/8 PX29T Axial Prefocus Base

Part No.	Bulb Type	Maximum Bulb Dia.	Volts	Amp	Qty	Notes
65/45 WATTS						
LB9004	HB1	5/8" (17mm)	12.8	5.08/3.51	1	
LB9004LL	HB1	5/8" (17mm)	12.8	5.08/3.51	1	Long-Life
65/55 WATTS						
LB9007	HB5	5/8" (17mm)	12.8	5.08/4.29	1	
LB9007LL	HB5	5/8" (17mm)	12.8	5.08/4.29	1	

MINIATURE INCANDESCENT BULBS

B-6 SC BAYONET BASE



Table 14-57: B-6 SC Bayonet Base

Part No.	Max. Bulb Dia.	Volts	Amp	Qty
12.032 WATTS				
LB1003	3/4" (19mm)	12.8	0.94	1
12.8 WATTS				
LB105	3/4" (19mm)	12.8	1	1

G-6 SC BAYONET BASE



Table 14-58: G-6 SC Bayonet Bas

Part No.	Max. Bulb Dia.	Volts	Amp	Qty	Notes
7.54 WATTS					
LB89	3/4" (19mm)	13	0.58	1	
7.83 WATTS					
LB97	3/4" (19mm)	13.5	0.58	1	
7.965 WATTS					
LB1155	3/4" (19mm)	13.5	0.59	1	2C-2R Filament
LB67	3/4" (19mm)	13.5	0.59	1	C-2R Filament
8.06 WATTS					
LB98	3/4" (19mm)	13	0.62	1	
8.4 WATTS					
LB303X	3/4" (19mm)	28	0.3	1	
8.82 WATTS					
LB631	3/4" (19mm)	14	0.63	1	

RP-11 SC BAYONET BASE

Table 14-59: RP-11 SC Bayonet Base

Part No.	Max. Bulb Dia.	Volts	Amp	Qty
37.5 WATTS				
LB1195	1-3/8" (35mm)	12.5	3	1

S-8 SC BAYONET BASE



LB199



LB1073



LB1141



LB1156



LB1203



LB1683



LB1691



LB7511

Table 14-60: S-8 SC Bayonet Base

Part No.	Max. Bulb Dia.	Volts	Amp	Qty	Notes
17.08 WATTS					
LB1691	1" (25mm)	28	0.61	1	
18.432 WATTS					
LB1141	1" (25mm)	12.8	1.44	1	
19.88 WATTS					
LB1203	1" (25mm)	12.5	0.71	1	21 Candle Power
21.12 WATTS					
LB7511	1" (25mm)	24	0.88	1	
23.04 WATTS					
LB1073	1" (25mm)	12.8	1.8	1	
26.88 WATTS					
LB1156	1" (25mm)	12.8	2.1	1	
28.56 WATTS					
LB1683	1" (25mm)	28	1.02	1	
28.8 WATTS					
LB199	1" (25mm)	12.8	2.25	1	

T-6 SC BAYONET BASE

LB5627

LB5637

Table 14-61: T-6 SC Bayonet

Part No.	Max. Bulb Dia.	Volts	Amp	Qty	Notes
5 WATTS					
LB5627	3/4" (19mm)	24	0.2	1	4 Candle Power
10 WATTS					
LB5637	3/4" (19mm)	24	0.42	1	

B-6 DC BAYONET BASE

Table 14-62: B-6 DC Bayonet

Part No.	Max. Bulb Dia.	Volts	Amp	Qty
12.032 WATTS				
LB1004	3/4" (19mm)	12.8	0.94	1

G-6 DC BAYONET BASE

Table 14-63: G-6 DC Bayonet

Part No.	Max. Bulb Dia.	Volts	Amp	Qty	Notes
6.44 WATTS					
LB1252	3/4" (19mm)	28	0.23	1	
7.54 WATTS					
LB90	3/4" (19mm)	13	0.58	1	
7.965 WATTS					
LB68	3/4" (19mm)	13.5	0.59	1	C-2R Filament
9.315 WATTS					
LB1178	3/4" (19mm)	13.5	0.69	1	C-2V Filament

S-8 DC BAYONET BASE



Table 14-64: S-8 DC Bayonet

Part No.	Max. Bulb Dia.	Volts	Amp	Qty	Notes
13.312 WATTS					
LB94	1" (25mm)	12.8	1.04	1	
17.15/8.26 WATTS					
LB1176	1" (25mm)	12.8/14	1.34/0.59	1	
18.432 WATTS					
LB1142	1" (25mm)	12.8	1.44	1	
23.04 WATTS					
LB1076	1" (25mm)	12.8	1.8	1	
25.2/9.52 WATTS					
LB1662	1" (25mm)	28/28	0.9/0.34	1	6 Candle Power
28.56 WATTS					
LB1638	1.04" (26.5mm)	28	1.02	1	32 Candle Power

S-8 DC INDEX BAYONET BASE



LB198



LB1034



LB1157



LB2057



LB7537

Table 14-65: S-8 DC Index Bayonet Base

Part No.	Max. Bulb Dia.	Volts	Amp	Qty
21.12/5.04 WATTS				
LB7537	1" (25mm)	24/24	0.88/0.21	1
23/8.59 WATTS				
LB1034	1" (25mm)	12.8/14	1.8/0.59	1
28.8/9.52 WATTS				
LB198	1" (25mm)	12.8/14	2.25/0.68	1
26.88/6.72 WATTS				
LB2057	1" (25mm)	12.8/14	2.1/0.48	1
26.88/8.26 WATTS				
LB1157	1" (25mm)	12.8/14	2.1/0.59	1

S-8 STANDARD BAYONET BASE



LB2057NA



LB1157NA

Table 14-66: S-8 Standard Bayonet Base

Part No.	Max. Bulb Dia.	Volts	Amp	Qty
26.88/6.72 WATTS				
LB2057NA	1.04" (26.5mm)	12.8/14	2.1/0.48	1
26.88/8.26 WATTS				
LB1157NA	1" (25mm)	12.8/14	2.1/0.59	1

S-8 D.F. PLASTIC WEDGE BASE



LB4157NALL



LB3157NA



LB3157



LB3057

Table 14-67: S-8 D.F. Plastic Wedge Base

Part No.	Max. Bulb Dia.	Volts	Amp	Qty	Notes
26.88/6.72 WATTS					
LB3057	1" (25mm)	12.8/14	2.1/0.48	1	
26.88/8.26 WATTS					
LB3157NA	1" (25mm)	12.8/14	2.1/0.59	1	
LB3157	1" (25mm)	12.8/14	2.1/0.59	1	
28.54/8.26 WATTS					
LB4157NALL	1" (25mm)	12.8/14	2.23/0.59	1	Long-Life

S-8 S.F. PLASTIC WEDGE BASE

Table 14-68: S-8 S.F. Plastic Wedge Base

Part No.	Max. Bulb Dia.	Volts	Amp	Qty
26.88 WATTS				
LB3156	1" (25mm)	12.8	2.1	1

T-1 1/2 M.F. SOCKET BASE

LB2721MF



LB2741MF



LB2752MF

Table 14-69: T-1 1/2 M.F. Socket Base

Part No.	Max. Bulb Dia.	Volts	Amp	Qty	Notes
1.2 WATTS					
LB2721MF	3/16" (4.8mm)	12	0.1	1	
1.5 WATTS					
LB2752MF	3/16" (4.8mm)	12	0.25	1	C-2V Filament
2.28 WATTS					
LB2741MF	3/16" (5mm)	12	0.19	1	

T-2 3/4 MINI BAYONET BASE

Table 14-70: T-2 3/4 Mini Bayonet Base

Part No.	Max. Bulb Dia.	Volts	Amp	Qty
2.04 WATTS				
LB3796	11/32" (8.7mm)	12	0.17	1

T-3 1/4 MINI BAYONET BASE



Table 14-71: T-3 1/4 Mini Bayonet Base

Part No.	Max. Bulb Dia.	Volts	Amp	Qty
1.12 WATTS				
LB1819	13/32" (10mm)	28	0.04	1
1.728 WATTS				
LB1892	13/32" (10mm)	14.4	0.12	1
1.96 WATTS				
LB1829	13/32" (10mm)	28	0.07	1
2.8 WATTS				
LB1815	13/32" (10mm)	14	0.2	1
2.8 WATTS				
LB1820	13/32" (10mm)	28	0.1	1
3.36 WATTS				
LB1891	13/32" (10mm)	14	0.24	1
3.78 WATTS				
LB1889	13/32" (10mm)	14	0.27	1
4.08 WATTS				
LB1818	13/32" (10mm)	24	0.17	1

Part No.	Max. Bulb Dia.	Volts	Amp	Qty
4.29 WATTS				
LB1816	13/32" (10mm)	13	0.33	1
4.62 WATTS				
LB1893	13/32" (10mm)	14	0.33	1
4.76 WATTS				
LB313	13/32" (10mm)	28	0.17	1

G-4 1/2 MINI BAYONET BASE



Table 14-72: G-4 1/2 Mini Bayonet Base

Part No.	Max. Bulb Dia.	Volts	Amp	Qty
2.87 WATTS				
LB55	9/16" (14mm)	7	0.41	1
3.36 WATTS				
LB57	9/16" (14mm)	14	0.24	1
3.78 WATTS				
LB1895	9/16" (14mm)	14	0.27	1
4.62 WATTS				
LB293	9/16" (14mm)	14	0.33	1
4.76 WATTS				
LB356	7/16" (11mm)	28	0.17	1
4.76 WATTS				
LB456	9/16" (14mm)	28	0.17	1

T-3 1/4 WEDGE BASE



LB73



LB85



LB158



LB168



LB192



LB193



LB194



LB194NA



LB464



LB658

Table 14-73: T-3 1/4 Wedge Base

Part No.	Max. Bulb Dia.	Volts	Amp	Qty	Notes
1.12 WATTS					
LB658	13/32" (10mm)	14	0.08	1	.31 Candle Power
1.12 WATTS					
LB73	7/32" (5.5mm)	14	0.08	1	.3 Candle Power
LB85	7/32" (5.5mm)	28	0.04	1	.3 Candle Power
3.36 WATTS					
LB158	13/32" (10mm)	14	0.24	1	2 Candle Power
3.78 WATTS					
LB194NA	13/32"(10mm)	14	0.27	1	2 Candle Power
LB194	13/32" (10mm)	14	0.27	1	2 Candle Power
4.29 WATTS					
LB192	13/32" (10mm)	13	0.33	1	2.7 Candle Power
4.62 WATTS					
LB193	13/32" (10mm)	14	0.33	1	
LB464	13/32" (10mm)	28	0.17	1	
4.9 WATTS					
LB168	13/32" (10mm)	14	0.35	1	3 Candle Power

T-5 WEDGE BASE



Table 14-74: T-5 Wedge Base

Part No.	Max. Bulb Dia.	Volts	Amp	Qty	Notes
9.315 WATTS					
LB904	5/8" (16mm)	13.5	0.69	1	4 Candle Power
LB906	5/8" (16mm)	13.5	0.69	1	6 Candle Power
12.8 WATTS					
LB912	5/8" (16mm)	12.8	1	1	
17.92 WATTS					
LB921	5/8" (16mm)	12.8	1.4	1	21 Candle Power

T-1 1/2 SUB MINI WEDGE BASE



Table 14-75: T-1 1/2 Sub Mini Wedge Base

Part No.	Max. Bulb Dia.	Volts	Amp	Qty
1.2 WATTS				
LB2721	3/16"(5mm)	12	0.1	1

T-1 3/4 SUB MINI WEDGE BASE

Table 14-76: T-1 3/4 Sub Mini Wedge Base

Part No.	Max. Bulb Dia.	Volts	Amp	Qty
1.26 WATTS				
LB37	1-7/32" (5.5mm)	14	0.09	1

B-6 RIGID LOOP BASE

Table 14-77: B-6 Rigid Loop Base

Part No.	Max. Bulb Dia.	Volts	Amp	Qty
12.032 WATTS				
LB561	3/8" (9.5mm)	12.8	0.97	1

T-3 DOUBLE MINI CAP BASE



Table 14-78: T-3 Double Mini Cap Base

Part No.	Max. Bulb Dia.	Volts	Amp	Qty	Notes
9.99 WATTS					
LB212-2	3/8" (9.5mm)	13.5	0.74	1	6 Candle Power
12.416 WATTS					
LB211-2	3/8" (9.5mm)	12.8	0.97	1	

T-2 1/4 DOUBLE FESTOON CAP BASE



T-2 1/4 Double Festoon Cap Base

Part No.	Max. Bulb Dia.	Volts	Amp	Qty
5 WATTS T-2 1/4				
LBDE3022	9/32" (7.1mm)	12	0.42	1

T-3 1/4 DOUBLE FESTOON CAP BASE



LB6423



LB6411



LBDE3175

Table 14-79: T-3 1/4 Double Festoon Cap Base

Part No.	Max. Bulb Dia.	Volts	Amp	Qty
5 WATTS T-3 1/4				
LB6423	13/32" (10mm)	24	0.2	1
10 WATTS T-3 1/4				
LB6411	13/32" (10mm)	12	0.83	1
LBDE3175	13/32" (10mm)	12	0.83	1

MOUNTING ACCESSORIES

BASES



LL091010



LL091110

Table 14-80: Bases

Part No.	Material	Measurements (L/ W/ H or Diam/ H)	Light Shape
LL091010	Chrome	1" x 4"	Rectangle
LL091110	Chrome	1-1/4" x 2-1/2"	Rectangle

BEZELS - CHROME



MD4304



MD4307

Table 14-81: Bezels -Chrome

Part No.	Material	Measurements (L/ W/ H or Diam/ H)	Light Shape
MD4304	Chrome	3" x 2"	Oval
MD4307	Chrome	6-5/8" x 2-1/4"	

BEZELS - CHROME PLATED

Table 14-82: Bezels - Chrome Plastic

Part No.	Measurements (L/ W/ H or Diam/ H)	Light Shape	Notes
WITHOUT VISOR			
MC0101	2-1/2"	Round	w/ out visor
MC0102	4"	Round	w/ out visor
MC0104	6"	Oval	w/ out visor
MC1616	2"	Round	w/ out visor
WITH VISOR			
MC0105	2-1/2"	Round	w/ visor
MC0106	4"	Round	w/ visor
MC0107	6"	Oval	w/ visor
MC1615	2"	Round	w/ visor
FOR DOUBLE BULL'S-EYE			
MC8973		Rectangle	
FOR MODEL 19 LAMP WITH MOUNTING PLATE			
MD5434			PB & KW

GROMMETS



Table 14-83: Grommets

Part No.	Material	Measurements (L/ W/ H or Diam/ H)	Light Shape
LL091910	Black Vinyl	2"	Round
LL092010	Black Vinyl	2-1/2"	Round
LL090710	Black Rubber	3" x 5"	Rectangle
LL092110	Black Vinyl	4"	Round
LL092210	Black Vinyl	6"	Oval

LIGHTING HARNESSES - CONTINUOUS



Table 14-84: Multi-Light Harnesses & Connectors

Part No.	Spacing	Roll (Feet)	Pins	Plugs	Notes
MD0100	6"	100 ft.	2	200	Standard Light Plugs
MD0229					PB, Y-Splitter, Air Cleaner Light Bar
MD0300	12"	100 ft.	3	100	Standard Light Plugs
MD1827	12"	100 ft.	2	100	Standard Light Plugs

LIGHTING PIGTAILS



LL091710

Table 14-85: Lighting Pigtails

Part No.	Product	Lead	Pins	Notes
LL091810	Pigtail	10"	3	Pigtail for Stop, Turn, and Tail Lights, Right Angle
LL091710	Pigtail	6"	2	Pigtail for Clearance & Marker Lights, Right Angle



*For information, updates, or corrections,
please contact us at feedback@TRPParts.com*

*No part of this marketing material may be
reproduced in any manner without written
permission from TRP® North America.*

**TRP100EN-A
06/14/2012**

TRP® North America

750 Houser Way N.
Renton, WA 98057

www.TRPParts.com